

Technical Data

**Types of 38mm DIAMETER
STAINLESS STEEL
GRAB BARS WITH SNAP FLANGE**

Made to Order

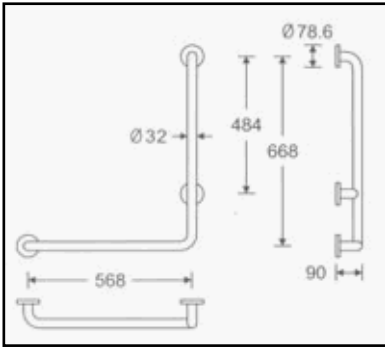

Type 001

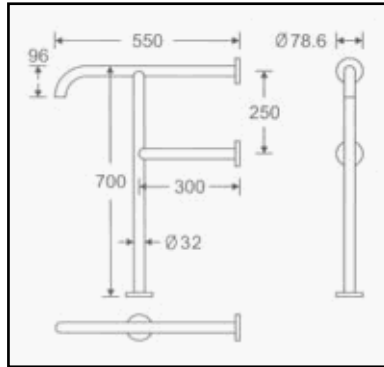

Type 002

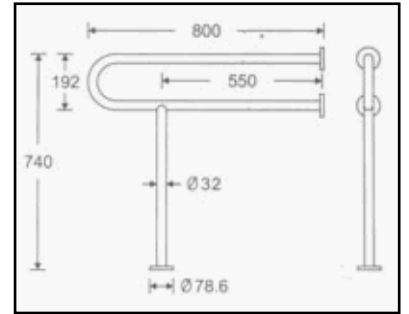

Type 003

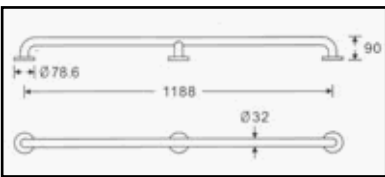

Type 004

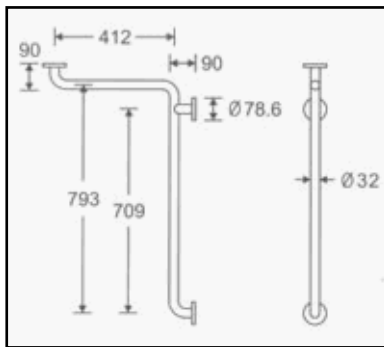

Type 005

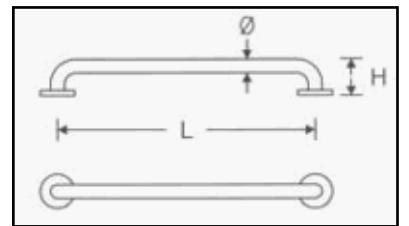

Type 006

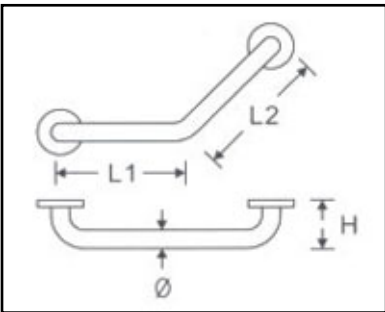

Type 007

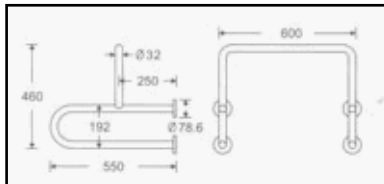

Type 008

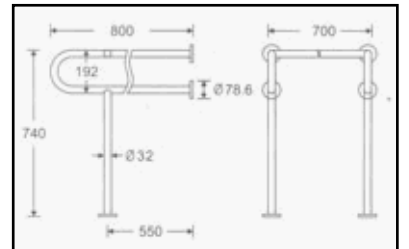

Type 009

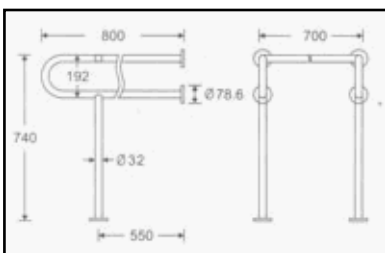

Type 010

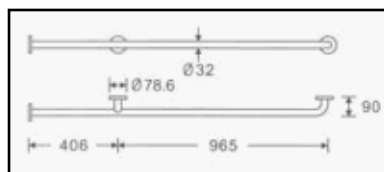

Type 011

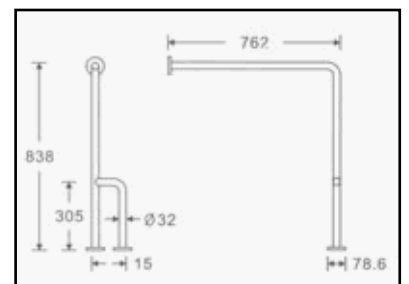

Type 012

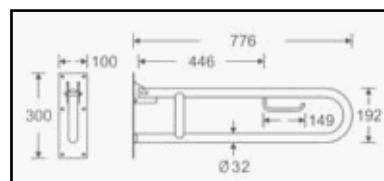

Type 013